

ELECTRIC

ACTUATORS & CONTROLS

WEATHERPROOF



EXPLOSION PROOF



ZENITH ELECTRIC ACTUATORS

ZE SERIES WEATHERPROOF ENCLOSURES ZX SERIES EXPLOSION PROOF ENCLOSURES

- Torques from 350 in lbs to 79,000 in lbs.
- Hard anodized interior; polyester powder coated exterior.
- Certifications and approvals:
 - IECEx (Ex db IIB T4 Gb, Ex tb IIIC T135°C Db)
 - ATEX (II 2G Ex db IIB T4 Gb, II 2D Ex tb IIIC T135°C Db)
 - KCs (Ex d IIB T4, Ex tD A21 IP6X, T135°C)
 - INMETRO (Ex db IIB T4 Gb, Ex tb IIIC T135°C Db)
 - EAC (1 Ex d IIB T4 Gb X, Ex tb IIIC T135°C Db)
 - CSA (Class I, Division 1, Groups C,D T4; Ex d IIB T4 Gb)
 - CCC (Ex db IIB T4 Gb, Ex tb IIIC T135°C Db)
 - SIL 2/3
 - RMRS type approval
 - ABS type approval
 - Turk Loydu type approval
 - RINA type approval
 - USCG test approval

IECEX CE 0344



OPTIONS

- Quarter turn
- Linear available



10080 Commerce Park Dr.
Cincinnati OH, 45246
513-499-3820
www.m-zcontrols.com

Distributed By:

ZENITH ELECTRIC ACTUATORS

MODELS	TORQUE (in-lbs)	OPERATING TIME (90° sec)		RATED CURRENT (A)														NUMBER OF HANDWHEEL (Gear) TURNS (0-90°)		
		50 Hz	60 Hz	12 VDC		24 VDC		110 VAC 1Φ		220 VAC 1Φ		380 VAC 3Φ		440 VAC 3Φ		460 VAC 3Φ			480 VAC 3Φ	
				50 Hz	60 Hz	50 Hz	60 Hz	50 Hz	60 Hz	50 Hz	60 Hz	50 Hz	60 Hz	50 Hz	60 Hz	50 Hz	60 Hz		50 Hz	60 Hz
ZE-350	350	12	12	1.0	0.5	0.1	0.1	-	-	-	-	-	-	-	-	-	-	-	-	Lever
ZE(ZX)-510	510	14	12	-	1.7	0.4	0.4	0.2	0.2	-	-	-	-	-	-	-	-	-	-	8.0
ZE(ZX)-710	710	16	13	10.2	3.7	1.2	1.1	0.6	0.6	0.3	0.2	0.3	0.2	-	-	-	-	-	-	10.0
ZE(ZX)-1320	1320	25	21	-	5.3	2.1	2.1	1.0	1.0	0.6	0.4	0.6	0.4	0.6	0.4	0.4	0.4	0.3	-	11.0
ZE(ZX)-1770	1770	25	21	-	6.5	2.2	2.1	1.1	1.1	0.7	0.5	0.6	0.4	0.6	0.4	0.4	0.3	-	-	11.0
ZE(ZX)-2700	2700	31	26	-	8.6	2.1	2.4	1.0	1.3	0.6	0.5	0.4	0.3	0.4	0.3	0.4	0.3	-	-	13.5
ZE(ZX)-4450	4450	31	26	-	-	3.3	4.2	1.7	1.9	0.9	0.8	0.8	0.5	0.7	0.5	0.7	0.5	-	-	13.5
ZE(ZX)-5300	5300	31	26	-	7.0	3.4	4.4	1.9	2.0	1.0	0.9	1.4	0.9	1.3	0.9	0.7	0.6	-	-	13.5
ZE(ZX)-7000	7000	37	31	-	8.6	5.4	5.7	2.6	2.8	1.3	1.0	1.7	0.9	1.6	0.9	1.1	0.8	-	-	16.5
ZE(ZX)-10600	10600	37	31	-	8.6	6.5	6.9	2.8	3.0	1.5	1.1	1.8	1.0	1.7	0.9	1.3	0.9	-	-	16.5
ZE(ZX)-17700	17700	112	93	-	8.6	5.4	5.7	3.1	3.0	1.4	1.0	1.7	1.0	1.6	0.9	1.2	0.8	-	-	49.5
ZE(ZX)-26500	26500	112	93	-	8.6	6.5	6.9	2.8	3.0	1.5	1.1	1.8	1.0	1.7	0.9	1.3	0.9	-	-	49.5

QUARTER-TURN ACTUATOR ZE

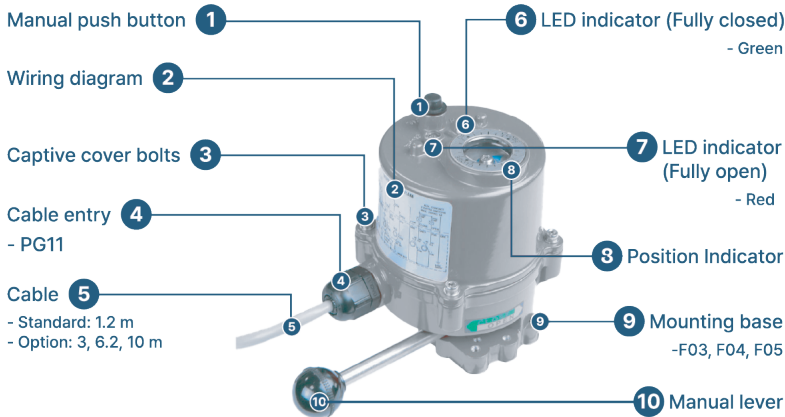

QUARTER-TURN ACTUATOR ZE/ZX

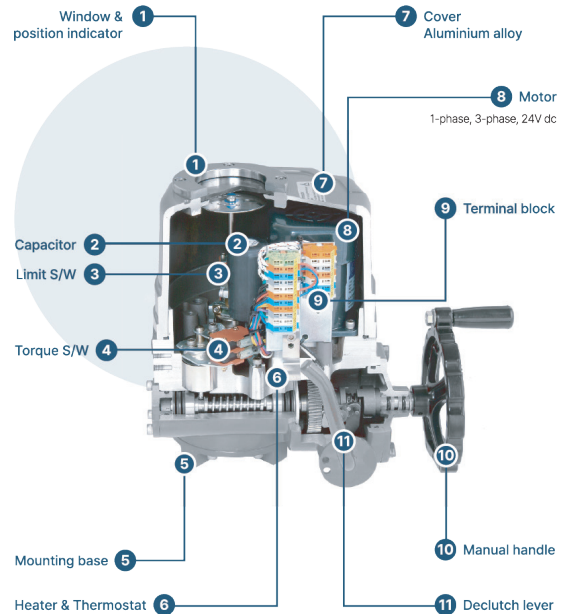

QUARTER-TURN ACTUATOR ZE/ZX

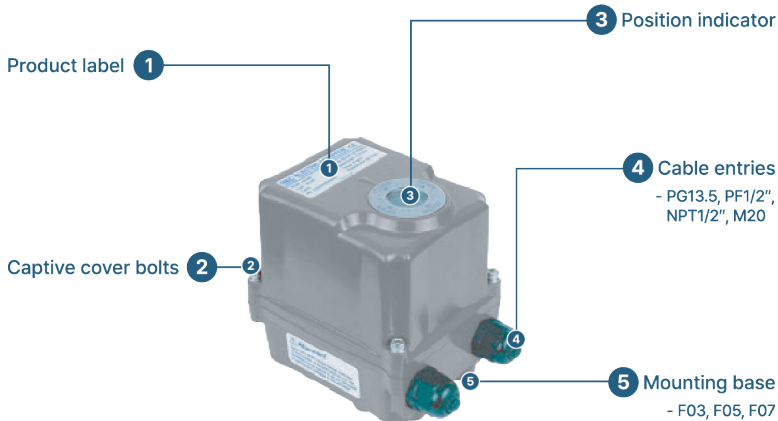

Cincinnati OH, 45246
513-499-3820
www.m-zcontrols.com

Distributed By:

ZENITH ELECTRIC ACTUATORS

LOCAL CONTROL UNIT-B: LCU-B

- Aluminum die-cast, compact size, and integrated design
- Weatherproof IP67 or IP68 option
- Integral starter (mechanical or electrical)
- Phase reversal protection with LED signal (yellow)
- Applicable models: ZE/ZX
- Power supply
 - 110/220 V ac 1-phase, 50/60 Hz, $\pm 10\%$
 - 220 to 480 V ac 3-phase, 50/60 Hz, $\pm 10\%$
- LED lamp indicators



LOCAL CONTROL UNIT-C: LCU-C

- Aluminum die-cast, compact size, and integrated design
- Weatherproof IP67 or IP68 option
- LCD monitor: digital indicators with numbers and graphs
- Separate terminal chamber
- Auto phase discriminator (easy and convenient wiring)
- Applicable models: ZE/ZX
- Power supply
 - 110/220 V ac 1-phase, 50/60 Hz, $\pm 10\%$
 - 220 to 480 V ac 3-phase, 50/60 Hz, $\pm 10\%$

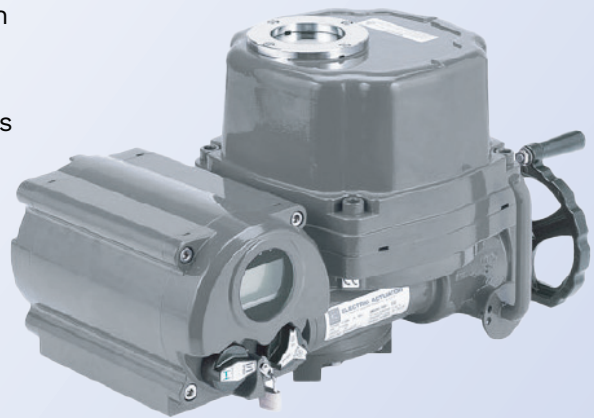

ZENITH ELECTRIC ACTUATORS

RECHARGEABLE BATTERY PACK: RBP

- Aluminum die-cast and compact size
- Emergency application in case of a power failure
- Applicable models:
 - ZE-710 to HQ-030, HQ-060 to HQ-300
- Power supply
 - 110/220 V ac 1-phase, 50/60 Hz, $\pm 10\%$
 - 24 V dc
- LED lamp indicators

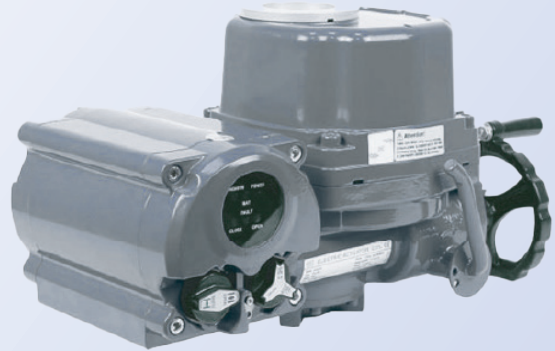

EXPLOSION PROOF LOCAL CONTROL UNIT-B(EX): LCU-B(EX)

- Flameproof (Ex db IIB T4) / Dust ignition proof (Ex tb IIIC T135°)
- Weatherproof IP67 or watertight IP68 option
- Applicable models: ZE-710 to HQ-300
- Power supply:
 - 110/220 V ac 1-phase, 50/60 Hz, $\pm 10\%$
 - 220 to 480 V ac 3-phase, 50/60 Hz, $\pm 10\%$
- LED lamp indicators



EXPLOSION PROOF LOCAL CONTROL UNIT-2B(EX): LCU-2B(EX)

- Flameproof (Ex db IIB T4) / Dust ignition proof (Ex tb IIIC T135°)
- Separate terminal chamber
- Weatherproof IP67 or watertight IP68 option
- Applicable models: ZE-710 to HQ-300
- Applicable cable entries: 5 x NPT3/4"
- Power supply:
 - 110/220 V ac 1-phase, 50/60 Hz, $\pm 10\%$
 - 220 to 480 V ac 3-phase, 50/60 Hz, $\pm 10\%$
- LED lamp indicators

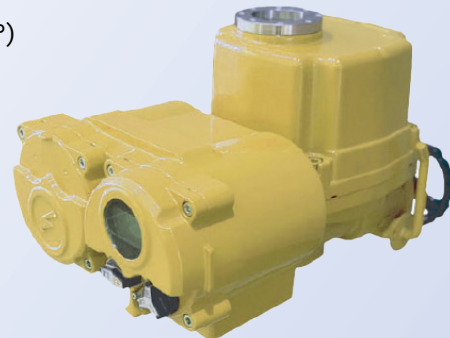

ZENITH ELECTRIC ACTUATORS

CONTROL BOARD OPTIONS

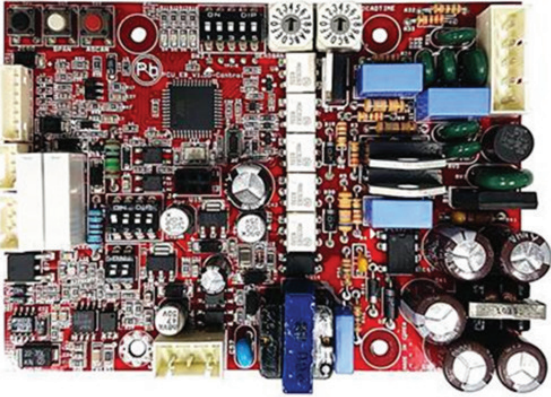

MODEL	PCU EB-V1.5D (for AC)	PCU DC-V2.1C (for DC)
Indicated on the Board	PCU_EB_V1.5D-CONTROL	HKC-PCU_DC-MAIN-V2.1C
Special Function	Applied Electronic Breaking System (EB) for High Resolution Control	NA
Power	110V/220V ac \pm 10%, 50/60Hz, 4VA max	
Input Signal (Set Point)	4~20mA dc, 0~20mA dc, 1~5V dc, 0~5V dc, 2~10V dc, 0~10V dc	
Input Impedance	100 k Ω and Over	
Output Signal (Feedback)	4~20mA dc, 0~20mA dc, 1~5V dc, 0~5V dc, 2~10V dc, 0~10V dc	
Output Impedance	100 Ω and Less	
Position Resistance	100~10 k Ω	
Dead Time	0.2~7.5 sec (It can be set in 16 step) <ul style="list-style-type: none"> • Step 0 : 0.2 sec • Step 1~4 : 0.25~1sec (0.25sec/step) • Step 5~15 : 2.5~7.5sec (0.5sec/step) 	
Dead Band	0.3~7.5 % (It can be set in 16 step) <ul style="list-style-type: none"> • Step 0 ~ 4 : 0.3~0.7 % (0.1 %/step) • Step 5 ~ 9 : 1 ~ 1.8 % (0.2 %/step) • Step 10 ~ 15 : 5 ~ 7.5 % (0.5 %/step) 	0.4~7.5 % (It can be set in 16 step) <ul style="list-style-type: none"> • Step 0~4 : 0.4~0.8 % (0.1 %/step) • Step 5~9 : 1 ~ 1.8 % (0.2 %/step) • Step 10~15 : 5 ~ 7.5 % (0.5 %/step)
Fault Mode	Fail Close, Fail Open, Fail Stop	
Position Conversion Accuracy	\pm (0.2 To 5)% (May Vary Depending on Conditions)	
Ambient Temperature	-25°C to 80°C	
Ambient Humidity	90% RH max. (Non-condensing Condition)	
Dielectric Strength	1500V ac, 1 Minute	500V ac, 1 Minute
Insulation Resistance	500V dc, 50M Ω or More	
Vibration and Shock	X, Y, Z axis 10g (@ 6g RMF), Frequency: 0.2-34 Hz, Time: Within 30 Minutes	

ZE-710 through ZE-7000

The super capacitor option provides instant power for fail-safe operation to a desired open or closed position.



Cincinnati OH, 45246
513-499-3820
www.m-zcontrols.com

Distributed By:

ZENITH ELECTRIC ACTUATORS

ZE-350 DIMENSIONS

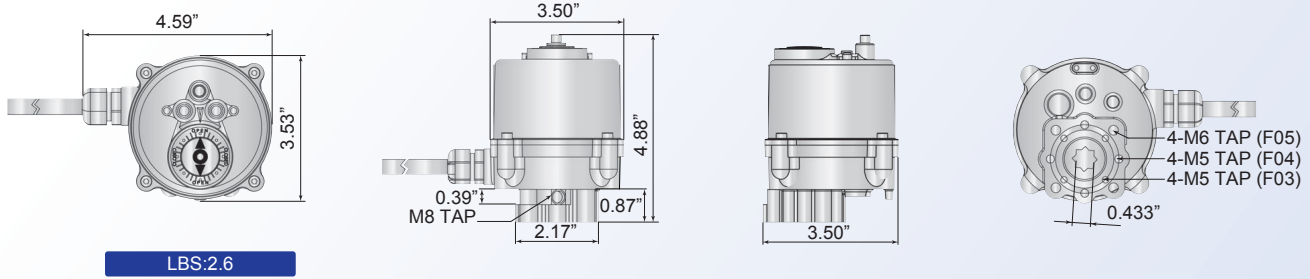

ZE-510 DIMENSIONS

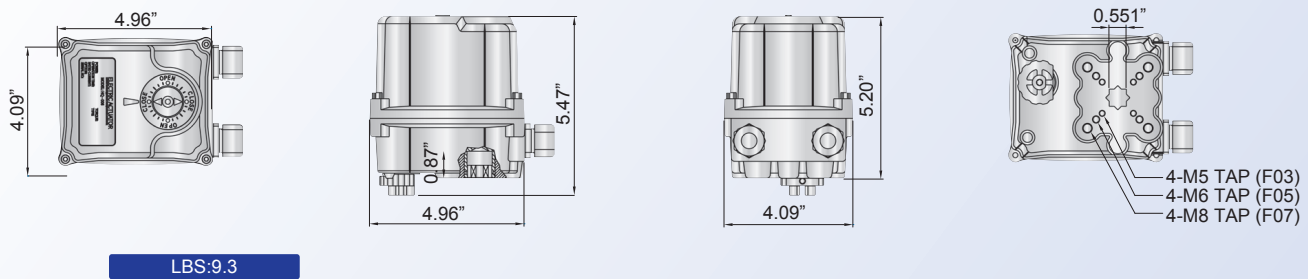

ZX-510 DIMENSIONS

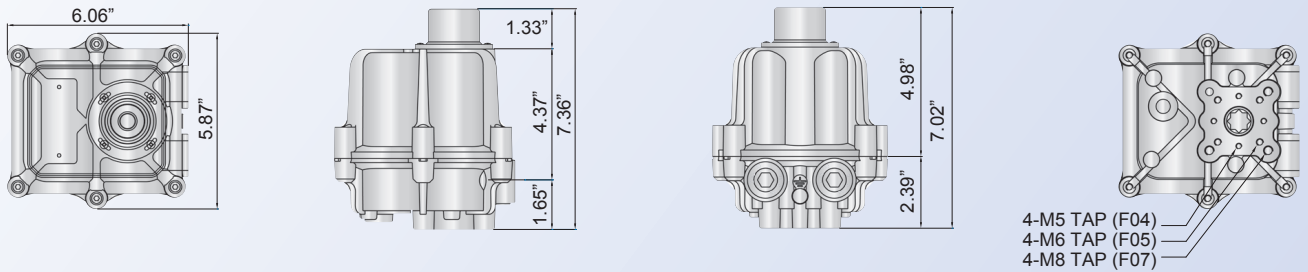

Cincinnati OH, 45246
513-499-3820
www.m-zcontrols.com

Distributed By:

ZENITH ELECTRIC ACTUATORS

ZE(ZX)-710 TO ZE(ZX)-10600

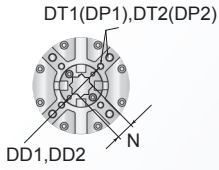

BASE ISO 5211

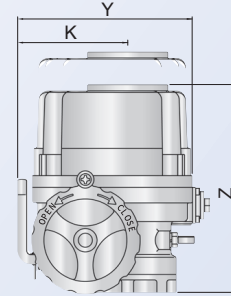
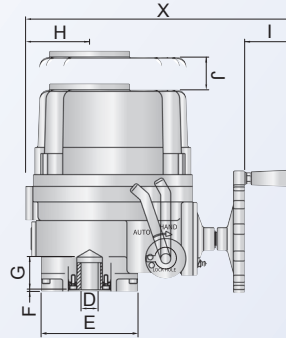
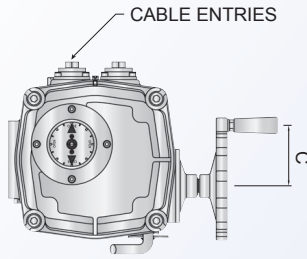

ZE(ZX)-17700 TO ZE(ZX)-26500

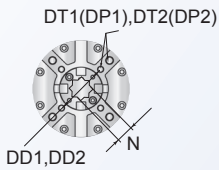

BASE ISO 5211

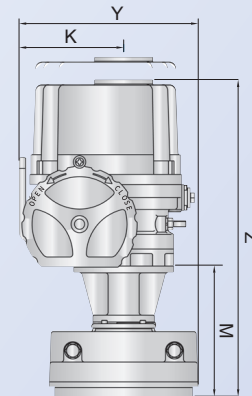
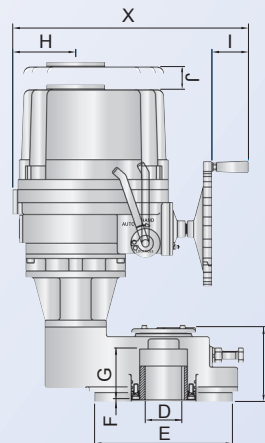
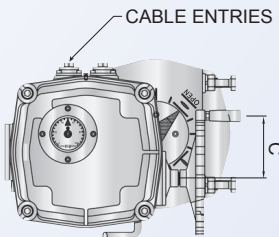

DIMENSIONS (IN)

SIZE	C	D	E	F	G	H	I	J	K	L	M	N	X	Y	Z	DD1	DD2	DP1	DP2	DT1	DT2	ISO 5211	LBS (ZE)
710	2.36	0.79	3.7	0.12	1.26	2.24	2.01	1.57	3.94	-	-	0.669	10.43	6.54	9.25	2.756	-	0.47	-	M8	-	F07	15.4
1320	3.07	0.87	4.92	0.12	1.69	3.27	2.56	2.13	5.59	-	-	0.748	13.7	10.04	10.55	2.756	4.016	0.47	0.59	M8	M10	F07/F10	30.9
1770	3.07	0.87	4.92	0.12	1.69	3.27	2.56	2.13	5.59	-	-	0.748	13.7	10.04	10.55	2.756	4.016	0.47	0.59	M8	M10	F07/F10	30.9
2700	3.07	1.38	5.83	0.12	1.93	3.62	2.56	2.56	6.3	-	-	1.063	13.7	10.04	11.42	4.016	4.921	0.59	0.71	M10	M12	F10/F12	39.7
4450	3.07	1.38	5.83	0.12	1.93	3.62	2.56	2.56	6.3	-	-	1.063	14.88	10.04	11.97	4.016	4.921	0.59	0.71	M10	M12	F10/F12	41.9
5300	3.07	1.38	5.83	0.12	1.93	3.62	2.56	2.56	6.3	-	-	1.063	14.88	10.04	11.97	4.016	4.921	0.59	0.71	M10	M12	F10/F12	41.9
7000	4.33	1.77	7.01	0.12	2.24	4.41	2.56	3.07	7.32	-	-	1.417	14.88	11.38	12.99	4.921	5.512	0.71	0.94	M12	M16	F12/F14	55.1
10600	4.33	1.77	7.01	0.12	2.24	4.41	2.56	3.07	7.32	-	-	1.417	16.5	11.38	12.99	4.921	5.512	0.71	0.94	M12	M16	F12/F14	55.1
17700	4.33	2.56	9.65	0.2	3.54	4.41	2.56	3.07	7.32	9.17	5.24	1.417	16.5	12.56	22.17	5.512	-	0.94	-	M16	-	F14	143.3
26500	4.33	2.56	9.65	0.2	3.54	4.41	2.56	3.07	7.32	9.17	5.24	1.417	16.5	12.56	22.17	5.512	-	0.94	-	M16	-	F14	143.3



Cincinnati OH, 45246
513-499-3820
www.m-zcontrols.com

Distributed By:

ZENITH ELECTRIC ACTUATORS

LOCAL CONTROL UNIT-B: LCU-B

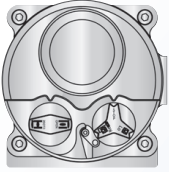

View A

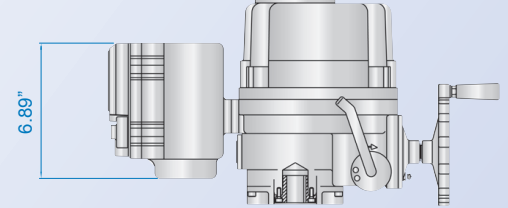
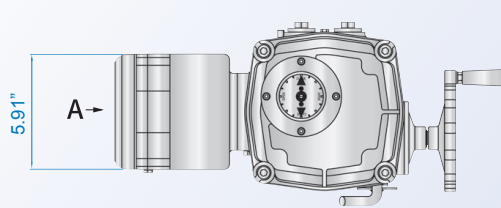

LOCAL CONTROL UNIT-C: LCU-C

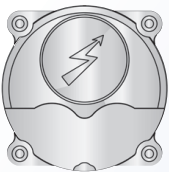

View A

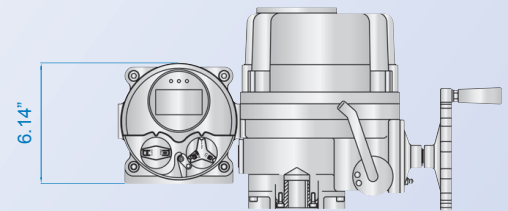
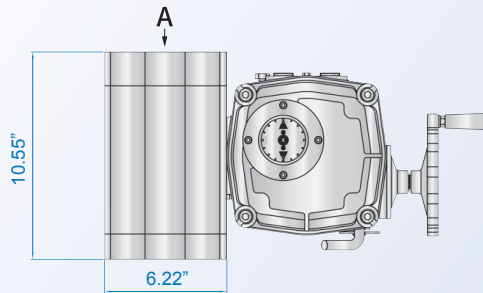

RECHARGEABLE BATTERY PACK: RBP

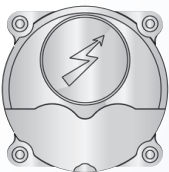

View A

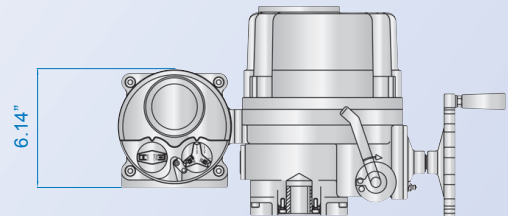
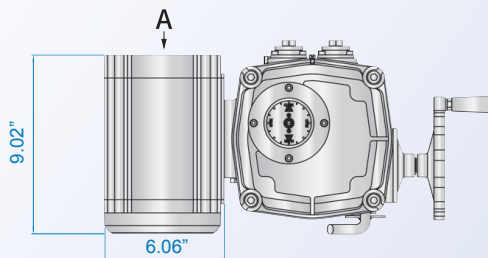

Cincinnati OH, 45246
513-499-3820
www.m-zcontrols.com

Distributed By:

ZENITH ELECTRIC ACTUATORS

EXPLOSION PROOF LOCAL CONTROL UNIT-B(EX): LCU-B(EX)

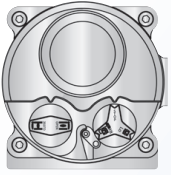

View A

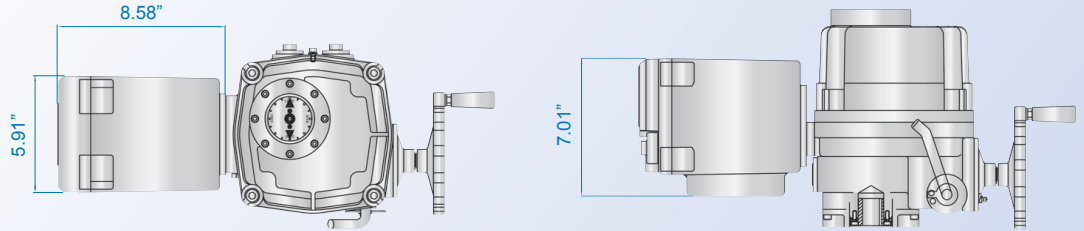

EXPLOSION PROOF LOCAL CONTROL UNIT-2B(EX): LCU-2B(EX)

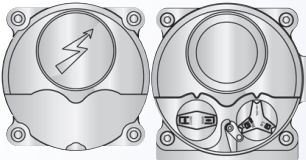

View A

View B

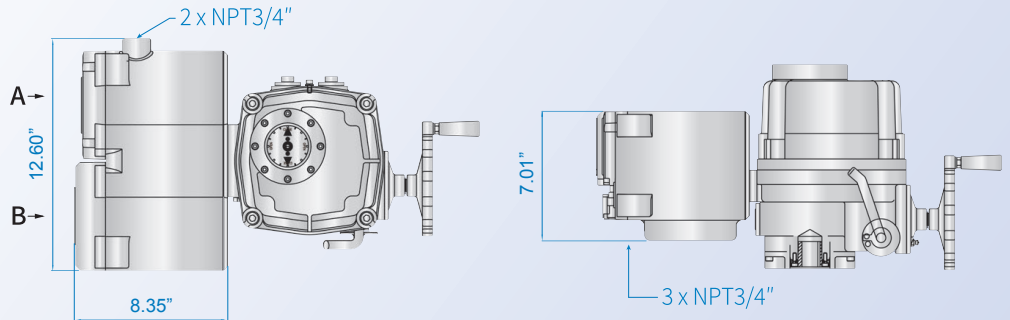

ZENITH ELECTRIC ACTUATORS

HOW TO ORDER

1) Series	2) Model	3) Supply Voltage	4) Control	
ZE Weatherproof NEMA TYPE 4, 4X, 6 IP 66,67 ZX Flame & Dust Ignition Proof Ex tb IIIC T135°C NEMA 4, 4X, 6 IP 66,67	00350 350 in-lbs 00510 510 in-lbs 00710 710 in-lbs 01320 1320 in-lbs 01770 1770 in-lbs 02700 2700 in-lbs 04450 4450 in-lbs 05300 5300 in-lbs 07000 7000 in-lbs 10600 10600 in-lbs 23800 17700 in-lbs 26500 26500 in-lbs	X 110 VAC 1Φ E 220 VAC 1Φ F 220 VAC 3Φ G 380 VAC 3Φ K 440 VAC 3Φ H 480 VAC 3Φ B 12 VDC C 24 VDC A 24V AC/DC	XX On/Off XR On/Off MODBUS XP On/Off PROFIBUS XT On/Off 4-20mA TRANSMITTER XO On/Off POTENTIOMETER FEEDBACK MX Proportional Control MR Proportional Control MODBUS MP Proportional Control PROFIBUS	
5) Local Control Unit			6) Rotation	
X None Z Local Control Unit Local Or Remote Selection LED Indication B Local Control Unit Integral Starter Local Or Remote Selection LED Indication C Local Control Unit Integral Starter Auto Phase Discriminator Separate Terminal Box Local Or Remote Selection LED Indication E Ex Local Control Unit Local Or Remote Selection LED Indication F Ex Local Control Unit Integral Starter Local Or Remote Selection LED Indication R Local Control Unit Rechargeable Battery Pack Local Or Remote Selection LED Indication S Ex Local Control Unit Rechargeable Battery Pack Local Or Remote Selection LED Indication D Local Control Unit Local Or Remote Selection A LCU: Super Capacitor			X 90° 2 Position On/Off Or Modulating A 90° On/Off 3 Position B 180° 2 Position On/Off Or Modulating C 180° On/Off 3 Position D 270° 2 Position On/Off Or Modulating E 270° On/Off 3 Position	
7) Speed	8) Temperature	9) Switches	10) Special 1	11) Special 2
X Standard A High Speed 2 Start Gear B High Speed 3 Start Gear	X Standard L Low Temperature -40 to +60°C	X Standard 2 SPDT ALS A 4 SPDT ALS	XX No Special 1 DD Drive Coupler DD DK Drive Coupler Key C5 C5-Coating C5 IL Indicator 3-Way L IT Indicator 3-Way T	XX No Special 2 CA Conduit M20 CB Conduit M25



Cincinnati OH, 45246
513-499-3820
www.m-zcontrols.com

Distributed By: